

HTU318

Ultrasonic sensors with 1 switching output

en 01-2017/02 50124859



Dimensioned drawing

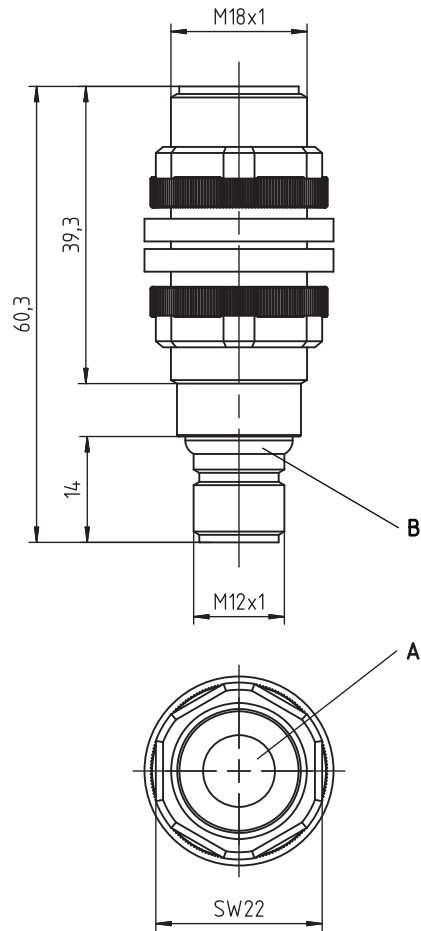

A Active sensor surface
B Indicator diodes

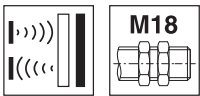

40 ... 300 mm
80 ... 1200 mm



- Function largely independent of surface properties, ideal for detection of liquids, bulk materials, transparent media, ...
- Small dead zone at long scanning range
- Adjustment of the switching point can be taught
- NO/NC function reversible
- 1 switching output (PNP or NPN)
- Extra short construction
- **NEW** – Stable plastic design
- **NEW** – Temperature-compensated scanning range

Electrical connection

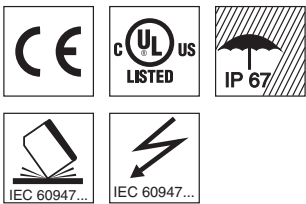

Accessories:

(available separately)

- Mounting systems
- Mounting adapter M18-M30: BTX-D18M-D30 (Part no. 50125860)
- Cables with M12 connector (KD ...)
- Teach adapter PA1/XTSX-M12 (Part no. 50124709)

We reserve the right to make changes • PAL_HTU318_300_1200_1SWO_en_50124859.fm

Technical data

Ultrasonic specifications

Scanning range ¹⁾
 Adjustment range
 Ultrasonic frequency
 Typ. opening angle
 Resolution
 Direction of beam
 Reproducibility
 Switching hysteresis
 Temperature drift

HTU318-300/...-M12

40 ... 300mm ²⁾
 40 ... 300mm
 300kHz
 $7^\circ \pm 2^\circ$
 $< 2\text{mm}$
 Axial
 $\pm 0.5\% \text{ }^1 \text{ }^3)$
 $1\% \text{ }^3)$
 $\leq 5\% \text{ }^4)$

HTU318-1200/...-M12

80 ... 1200mm ²⁾
 80 ... 1200mm
 200kHz
 $8^\circ \pm 2^\circ$
 $< 2\text{mm}$
 Axial
 $\pm 0.5\% \text{ }^1 \text{ }^3)$
 $1\% \text{ }^3)$
 $\leq 5\% \text{ }^4)$

Timing

Switching frequency
 Response time
 Readiness delay

8Hz
 62ms
 $< 100\text{ms}$

5Hz
 100ms
 $< 100\text{ms}$

Electrical data

Operating voltage U_B ⁵⁾
 Residual ripple
 Open-circuit current
 Switching output

10 ... 30V DC (incl. $\pm 5\%$ residual ripple)
 $\pm 5\%$ of U_B
 $\leq 35\text{mA}$
 .../4... 1 PNP transistor switching output
 .../2... 1 NPN transistor switching output
 NO (normally open), preset
 Max. 150mA
 1-point teach: teach-in (pin 2) 2 ... 7s to U_B ,
 2-point teach: teach-in (pin 2) 7 ... 12s to U_B
 Teach-in (pin 2) $> 12\text{s}$ to U_B

Function
 Output current
 Switching range adjustment

Changeover
 NO/NC

Indicators

Yellow LED
 Yellow LED, flashing
 Green and yellow LEDs flashing
 Green LED

OUT1: object detected
 Teach-in
 Teaching error
 Object within the scanning range

Mechanical data

Housing
 Active surface
 Weight
 Ultrasonic transducer
 Connection type
 Fitting position

Plastic (PBT)
 Epoxy resin, glass fiber reinforced
 65g
 Piezoceramic ⁶⁾
 M12 connector, 4-pin
 Any

Environmental data

Ambient temp. (operation/storage)
 Protective circuit ⁷⁾
 VDE protection class
 Degree of protection
 Standards applied
 Certifications

$-20^\circ \dots +70^\circ\text{C}/-20^\circ \dots +70^\circ\text{C}$
 1, 2, 3
 III
 IP 67
 EN 60947-5-2
 UL 508, CSA C22.2 No.14-13 ^{5) 8)}

- 1) At 20°C
- 2) Target: 100mm x 100mm plate
- 3) From end value
- 4) Over the temperature range $-20^\circ\text{C} \dots +70^\circ\text{C}$
- 5) For UL applications: use is permitted exclusively in Class 2 circuits according to NEC
- 6) The ceramic material of the ultrasonic transducer contains lead zirconium titanate (PZT)
- 7) 1=short-circuit and overload protection, 2=polarity reversal protection, 3=wire break and inductive protection
- 8) These proximity switches shall be used with UL Listed Cable assemblies rated 30V, 0.5A min, in the field installation, or equivalent (categories: CYJV/CYJV7 or PVVA/PVVA7)

Diagrams

HTU318-300/...-M12

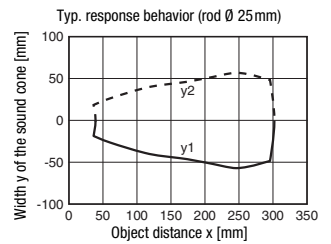
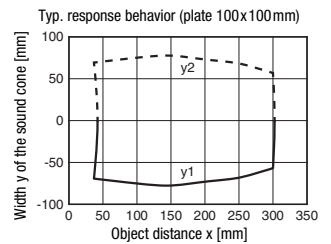

HTU318-1200/...-M12

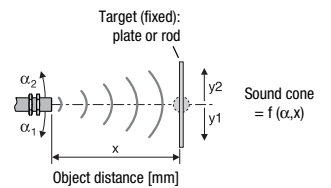
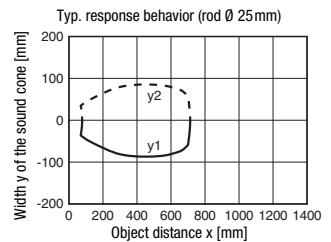
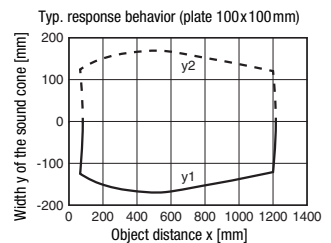

Notes

Observe intended use!

- ⚠ This product is not a safety sensor and is not intended as personnel protection.
- ⚠ The product may only be put into operation by competent persons.
- ⚠ Only use the product in accordance with its intended use.

HTU318

Ultrasonic sensors with 1 switching output

Part number code

H	T	U	3	1	8	-	1	2	0	0	.	3	/	4	T	-	M	1	2
---	---	---	---	---	---	---	---	---	---	---	---	---	---	---	---	---	---	---	---

Operating principle

HTU Ultrasonic sensor, scanning principle, with background suppression

DMU Ultrasonic sensor, distance measurement

Series

318 318 series, cylindrical short M18 design

Scanning range in mm

300 40 ... 300

1200 80 ... 1200

Equipment (optional)

.3 Teach button on the sensor

Pin assignment of connector pin 4 / black cable wire (OUT1)

4 PNP output, NO contact preset

P PNP output, NC contact preset

2 NPN output, NO contact preset

N NPN output, NC contact preset

C Analog output 4 ... 20mA

V Analog output 0 ... 10V

Pin assignment of connector pin 2 / white cable wire (Teach-IN)

T Teach input

Connection technology

M12 M12 connector, 4-pin

Order guide

The sensors listed here are preferred types; current information at www.leuze.com.

Scanning range / switching output	Designation	Part no.
40 ... 300mm / PNP	HTU318-300/4T-M12	50136070
40 ... 300mm / NPN	HTU318-300/2T-M12	50136071
80 ... 1200mm / PNP	HTU318-1200/4T-M12	50136074
80 ... 1200mm / NPN	HTU318-1200/2T-M12	50136075

Device functions and indicators

All settings on the sensor are taught-in via the **Teach-IN** input. Device status and switching states are indicated as follows by means of a LED:

Switching behavior

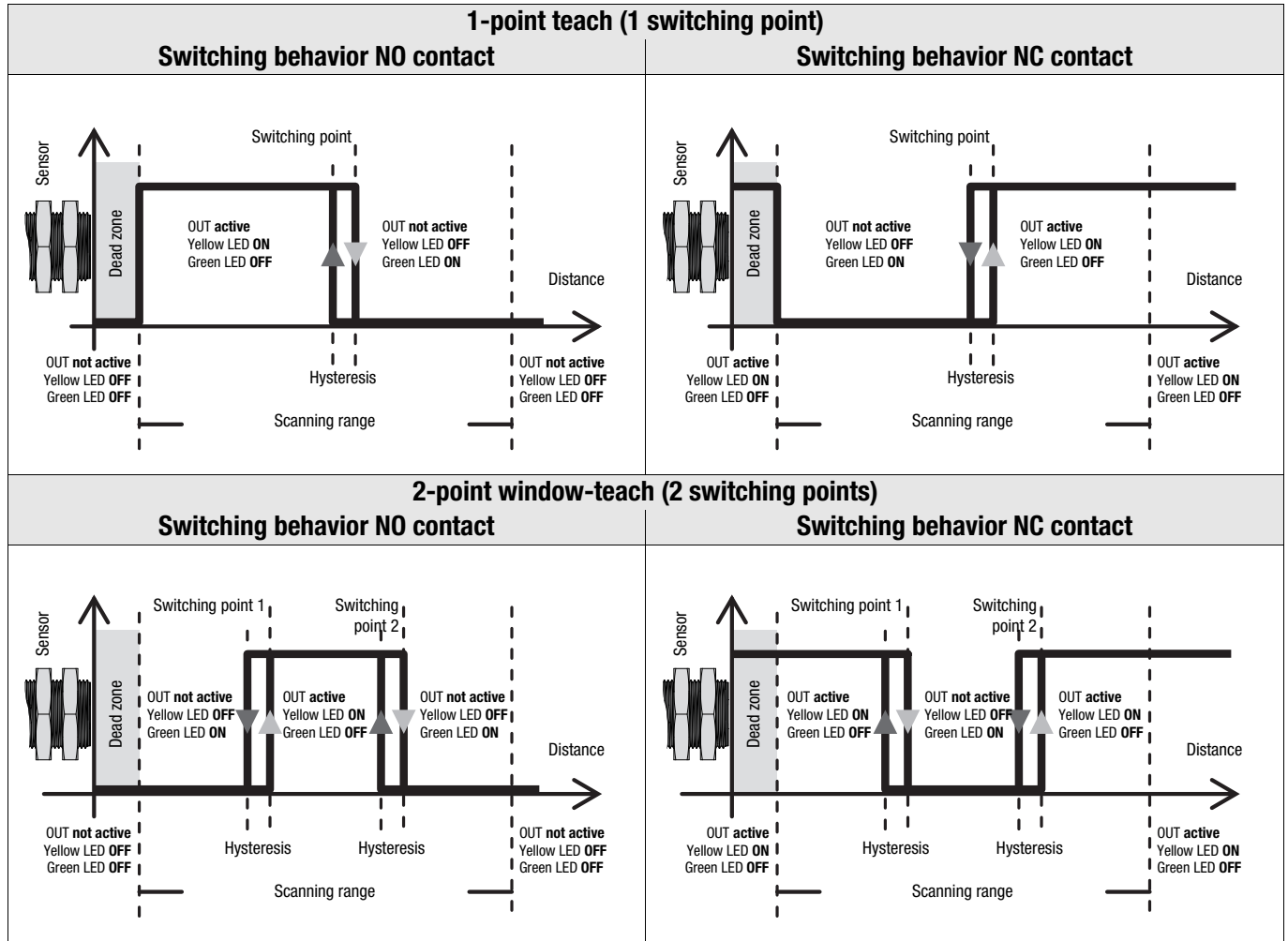

Note!
The switching behavior is not defined in the dead zone.

Switching behavior with 2-point window-teach as a function of the switching function

Switching function configured as	First taught object distance	Second taught object distance	Output switching behavior
NO (normally open)	Far	Close	
	Close	Far	
NC (normally closed)	Far	Close	
	Close	Far	

Adjusting the switching point via the teach input

The switching point of the sensor is set to 300mm or 1200mm on delivery.

By means of a simple teach event, the switching points can be individually taught to an arbitrary distance within the scanning range with 1-point teach (static) or 2-point window-teach (static). The Leuze **PA1/XTSX-M12** Teach Adapter can be used for this purpose. The adapter can also be used to easily switch the output function from NO contact to NC contact.

1-point teach (static)	2-point window-teach (static)
1. Place object at desired switching distance.	1. First, place object at desired switching distance for switching point 1 .
2. To adjust output OUT1, connect the Teach-IN input to U_B for 2 ... 7s (Leuze Teach Adapter: position "Teach-U _B "). The current state of output OUT1 is frozen while the adjustment is made.	2. To adjust output OUT1, connect the Teach-IN input to U_B for 7 ... 12s (Leuze Teach Adapter: position "Teach-U _B ") until the yellow and green LEDs flash alternately at 3Hz .
3. The yellow LED flashes at 3Hz and is then ON . The current object distance has been taught as the new switching point.	3. Release the button. The sensor remains in teach mode and the LEDs continue to flash.
4. Error-free teach: LED states and switching behavior according to the diagram shown above. Faulty teach (object may be too close or too far away – please note scanning range): green and yellow LEDs flash at 8Hz until an error-free teach event is performed. The output OUT1 is inactive as long as there is a teaching error.	4. Then, place the object at the desired switching distance for switching point 2 . Note: The minimum distance between the switching points is as follows: scanning range of 400mm: 40mm scanning range of 1200mm: 120mm
	5. To complete the teach event, briefly connect the Teach-IN input to U_B again (Leuze Teach Adapter: position "Teach-U _B "). The switching window was taught in.
	6. Error-free teach: LED states and switching behavior according to the diagram shown above. Faulty teach (object may be too close or too far away – please note scanning range): green and yellow LEDs flash at 8Hz until an error-free teach event is performed.

Adjusting the switching function (NC/NO) via the teach input

The switching function of the sensor is preset as follows on delivery:

- **OUT 1: NO contact**

The output function can be switched from NO contact (NO - normally open) to NC contact (NC - normally closed) and vice versa. Leuze Teach Adapter **PA1/XTSX-M12** can be used for this purpose. If the switching function is changed, the switching output is changed to the opposite state (toggled).

Changeover of the switching function
1. To change the switching function, connect the Teach-IN input to U_B for more than 12s (Leuze Teach Adapter: position "Teach-U _B "). The current state of output OUT1 is frozen while the adjustment is made.
2. The green and yellow LEDs flash alternately at 2 Hz . The switching function was changed over. The switching behavior corresponds to the diagram shown above.

Resetting to factory settings

The sensor can be reset to the factory setting (one switching point at 300 mm or 1200 mm). Leuze Teach Adapter **PA1/XTSX-M12** can be used for this purpose.

Resetting to factory settings
1. When switching on the supply voltage (during Power-On), connect the Teach-IN input to U_B for > 5s (Leuze Teach Adapter position "Teach-U _B "). The green and yellow LEDs flash alternately and very quickly for a brief time.
2. Disconnect the Teach-IN input from U_B . The sensor was reset to the factory setting: 1 switching point at 300 mm or 1200 mm (1-point teach, static).